

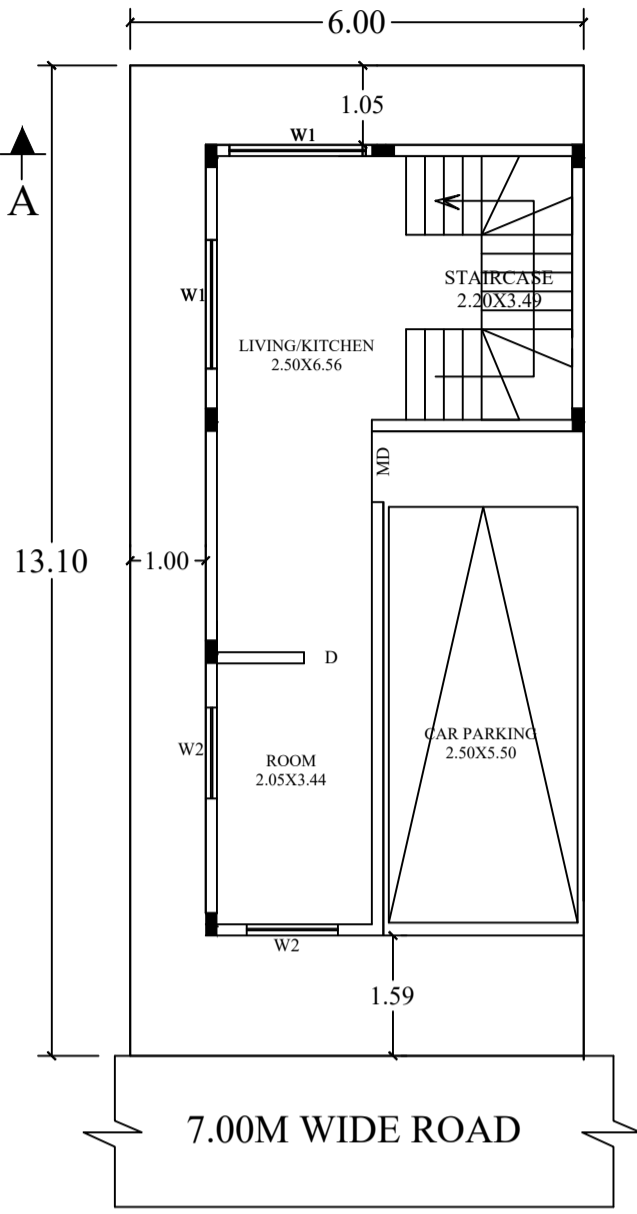

Color Notes

COLOR INDEX

- PLOT BOUNDARY
ABUTTING ROAD
PROPOSED WORK (COVERAGE AREA)
EXISTING (To be retained)
EXISTING (To be demolished)

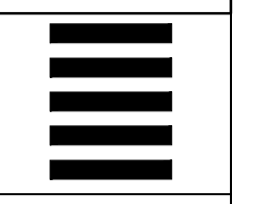

GROUND FLOOR PLAN

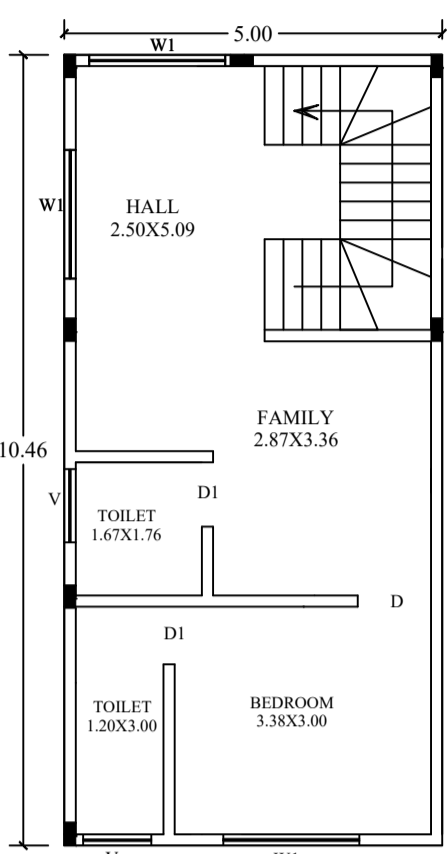

FIRST FLOOR PLAN

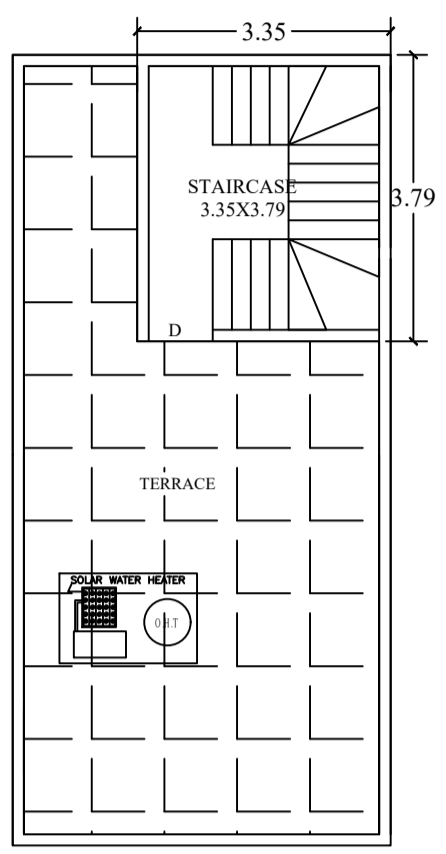

TERRACE FLOOR PLAN

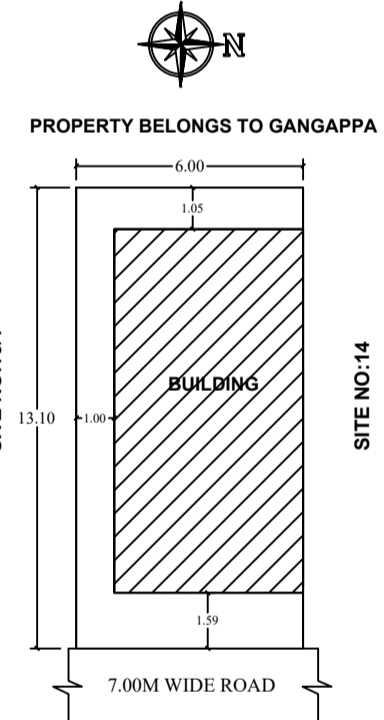

SITE PLAN

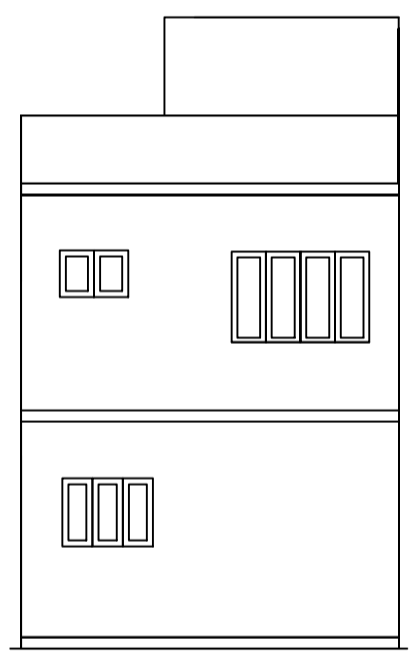

FRONT ELEVATION

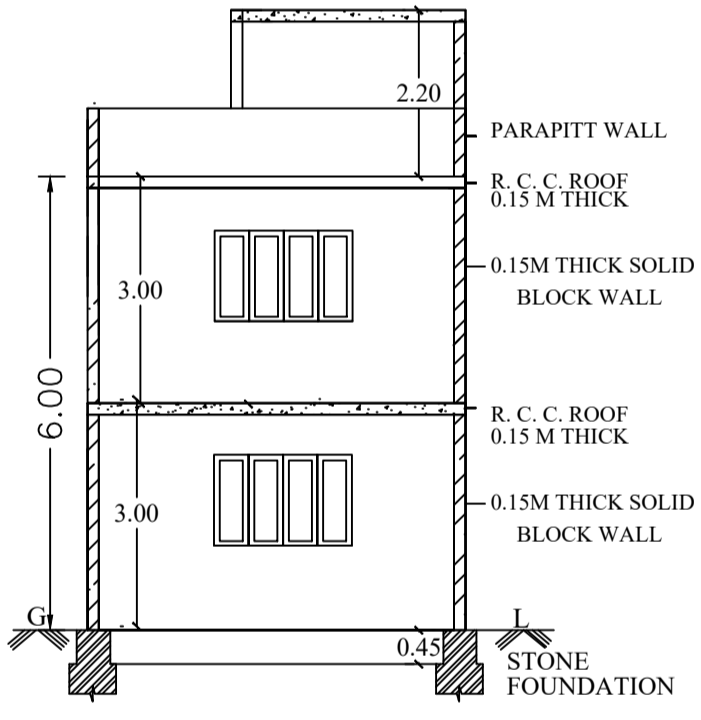

SECTION AT A-A

Approval Condition :

This Plan Sanction is issued subject to the following conditions :

- 1.The sanction is accorded for...
2.The sanction is accorded for Semidetached A (A) only...
3.Car Parking reserved in the plan should not be converted for any other purpose...
4.Development charges towards increasing the capacity of water supply, sanitary and power main has to be paid to BWSSB and BESCOM if any...
5.Necessary ducts for running telephone cables, cubicles at ground level for postal services & space for dumping garbage within the premises shall be provided...
6.The applicant shall construct temporary toilets for the use of construction workers and it should be demolished after the construction...
7.The applicant shall INSURE all workmen involved in the construction work against any accident / untoward incidents arising during the time of construction...
8.The applicant shall not stock any building materials / debris on footpath or on roads or on drains...
9.The applicant / builder is prohibited from selling the setback area / open spaces and the common facility areas, which shall be accessible to all the tenants and occupants...
10.If any owner / builder contravenes the provisions of Building Bye-laws and rules in force, the Architect / Engineer / Supervisor will be informed by the Authority in the first instance, warned in the second instance and cancel the registration if the same is repeated for the third time...
11.The applicant shall provide a separate room preferably 4.50 x 3.65 m in the basement for installation of telecom equipment and also to make provisions for telecom services as per Bye-law No. 25...
12.The applicant shall maintain during construction such barricading as considered necessary to prevent dust, debris & other materials endangering the safety of people / structures etc. in & around the site...
13.Permission shall be obtained from forest department for cutting trees before the commencement of the work...
14.License and approved plans shall be posted in a conspicuous place of the licensed premises. The building license and the copies of sanctioned plans with specifications shall be mounted on a frame and displayed and they shall be made available during inspections...
15.If any owner / builder contravenes the provisions of Building Bye-laws and rules in force, the Architect / Engineer / Supervisor will be informed by the Authority in the first instance, warned in the second instance and cancel the registration if the same is repeated for the third time...
16.Technical personnel, applicant or owner as the case may be shall strictly adhere to the duties and responsibilities specified in Schedule - IV (Bye-law No. 3.6) under sub section IV-8 (e) to (k)...
17.The building shall be constructed under the supervision of a registered structural engineer...
18.On completion of foundation or footings before erection of walls on the foundation and in the case of columnar structure before erecting the columns "COMMENCEMENT CERTIFICATE" shall be obtained...
19.Construction or reconstruction of the building should be completed before the expiry of five years from the date of issue of license & within one month after its completion shall apply for permission to occupy the building...
20.The building should not be occupied without obtaining "OCCUPANCY CERTIFICATE" from the competent authority...
21.Drinking water supplied by BWSSB should not be used for the construction activity of the building...
22.The applicant shall ensure that the Rain Water Harvesting Structures are provided & maintained in good repair for storage of water for non potable purposes or recharge of ground water at all times having a minimum total capacity mentioned in the Bye-law 32(a)...
23.The building shall be designed and constructed adopting the norms prescribed in National Building Code and in the "Criteria for earthquake resistant design of structures" bearing No. IS 1893-2002 published by the Bureau of Indian Standards making the building resistant to earthquake...
24.The applicant should provide solar water heaters as per table 17 of Bye-law No. 29 for the building...
25.Facilities for physically handicapped persons prescribed in schedule XI (Bye laws - 31) of Building bye-laws 2003 shall be ensured...
26.The applicant shall provide at least one common toilet in the ground floor for the use of the visitors / servants / drivers and security men and also entrance shall be approached through a ramp for the Physically Handicapped persons together with the stepped entry...
27.The Occupancy Certificate will be considered only after ensuring that the provisions of conditions vide SI. No. 23, 24, 25 & 26 are provided in the building...
28.The applicant shall ensure that no inconvenience is caused to the neighbors in the vicinity of construction and that the construction activities shall stop before 10.00 PM and shall not resume the work earlier than 7.00 AM to avoid hindrance during late hours and early morning hours...
29.Garbage originating from Apartments / Commercial buildings shall be segregated into organic and inorganic waste and should be processed in the Recycling processing unit --- k-g capacity installed at site for its re-use / disposal (Applicable for Residential units of 20 and above and 2000 Sqm and above built up area for Commercial building)...
30.The structures with basements shall be designed for structural stability and safety to ensure for soil stabilization during the course of excavation for basements with safe design for retaining walls and super structure for the safety of the structure as well as neighboring property, public roads and footpaths, and besides ensuring safety of workman and general public by erecting safe barricades.

- 31.Sufficient two wheeler parking shall be provided as per requirement...
32.Traffic Management Plan shall be obtained from Traffic Management Consultant for all high rise structures which shall be got approved from the Competent Authority if necessary...
33.The Owner / Association of high-rise building shall obtain clearance certificate from Karnataka Fire and Emergency Department every Two years with due inspection by the department regarding working condition of Fire Safety Measures installed. The certificate should be produced to the Corporation and shall get the renewal of the permission issued once in two years...
34.The Owner / Association of high-rise building shall get the building inspected by empaneled agencies of the Karnataka Fire and Emergency Department to ensure that the equipment's installed are in good and workable condition, and an affidavit to that effect shall be submitted to the Corporation and Fire Force Department every year...
35.The Owner / Association of high-rise building shall obtain clearance certificate from the Electrical Inspectorate every Two years with due inspection by the Department regarding working condition of Electrical installation / Lifts etc., The certificate should be produced to the BBMP and shall get the renewal of the permission issued that once in Two years...
36.The Owner / Association of the high-rise building shall conduct two mock - trials in the building one before the onset of summer and another during the summer and assure complete safety in respect of fire hazards...
37.The Builder / Contractor / Professional responsible for supervision of work shall not materially and structurally deviate the construction from the sanctioned plan, without previous approval of the authority. They shall explain to the owner s about the risk involved in contravention of the provisions of the Act, Rules, Bye-laws, Zoning Regulations, Standing Orders and Policy Orders of the BBMP...
38.The construction or reconstruction of a building shall be commenced within a period of two (2) years from date of issue of licence. Before the expiry of two years, the Owner / Developer shall give intimation to BBMP (Sanctioning Authority) of the intention to start work in the form prescribed in Schedule VI. Further, the Owner / Developer shall give intimation on completion of the foundation or footing of walls / columns of the foundation. Otherwise the plan sanction deemed cancelled...
39.In case of Development plan, Parks and Open Spaces area and Surface Parking area shall be earmarked and reserved as per Development Plan issued by the Bangalore Development Authority...
40.All other conditions and conditions mentioned in the work order issued by the Bangalore Development Authority while approving the Development Plan for the project should be strictly adhered to...
41.The Applicant / Owner / Developer shall abide by the collection of solid waste and its segregation as per solid waste management bye-law 2016...
42.The applicant/owner/developer shall abide by sustainable construction and demolition waste management as per solid waste management bye-law 2016...
43.The Applicant / Owners / Developers shall make necessary provision to charge electrical vehicles...
44.The Applicant / Owner / Developer shall plant one tree for a) sites measuring 180 Sqm up to 240 Sqm b) minimum of two trees for sites measuring with more than 240 Sqm. c) One tree for every 240 Sq.m of the FAR area as part thereof in case of Apartment / group housing / multi-dwelling unit/development plan...
45.In case of any false information, misrepresentation of facts, or pending court cases, the plan sanction is deemed cancelled...
46.Also see, building licence for special conditions, if any.
Special Condition as per Labour Department of Government of Karnataka vide ADDENDUM (Hosadaagi Hoodike) Letter No. LD/95/LET/2013, dated: 01-04-2013 :

Approval Date :

- 1.Registration of Applicant / Builder / Owner / Contractor and the construction workers working in the construction site with the "Karnataka Building and Other Construction workers Welfare Board" should be strictly adhered to...
2.The Applicant / Builder / Owner / Contractor should submit the Registration of establishment and list of construction workers engaged at the time of issue of Commencement Certificate. A copy of the same shall also be submitted to the concerned local Engineer in order to inspect the establishment and ensure the registration of establishment and workers working at construction site or work place...
3.The Applicant / Builder / Owner / Contractor shall also inform the changes if any of the list of workers engaged by him...
4.At any point of time No Applicant / Builder / Owner / Contractor shall engage a construction worker in his site or work place who is not registered with the "Karnataka Building and Other Construction workers Welfare Board".
Note :
1.Accommodation shall be provided for setting up of schools for imparting education to the children of construction workers in the labour camps / construction sites.
2.List of children of workers shall be furnished by the builder / contractor to the Labour Department which is mandatory.
3.Employment of child labour in the construction activities strictly prohibited.
4.Obtaining NOC from the Labour Department before commencing the construction work is a must.
5.BBMP will not be responsible for any dispute that may arise in respect of property in question.
6.In case if the documents submitted in respect of property in question is found to be false or fabricated, the plan sanctioned stands cancelled automatically and legal action will be initiated.

Table with 6 columns: Floor Name, Total Built Up Area (Sq.mt.), Deductions (Area in Sq.mt.), Proposed FAR Area (Sq.mt.), Total FAR Area (Sq.mt.), Tnmt (No.). Rows include Terrace Floor, First Floor, Ground Floor, and Totals.

Table with 6 columns: FLOOR, Name, UnitBUA Type, UnitBUA Area, Carpet Area, No. of Rooms, No. of Tenement. Rows include GROUND FLOOR PLAN, FIRST FLOOR PLAN, and Totals.

Table with 6 columns: Block, No. of Same Bldg, Total Built Up Area (Sq.mt.), Deductions (Area in Sq.mt.), Proposed FAR Area (Sq.mt.), Total FAR Area (Sq.mt.), Tnmt (No.). Rows include A (A) and Grand Total.

Table with 4 columns: BLOCK NAME, LENGTH, NOS. Rows include A (A) with D1 and D.

Table with 4 columns: BLOCK NAME, NAME, LENGTH, NOS. Row includes A (A) with V.

Table with 5 columns: Vehicle Type, No., Reqd. Area (Sq.mt.), No., Achieved Area (Sq.mt.). Rows include Car, Total Car, TwoWheeler, Other Parking, and Total.

Table with 7 columns: Block Name, Type, SubUse, Area (Sq.mt.), Units (Reqd, Prop), Car (Reqd, Prop). Rows include A (A) Residential Semidetached and Total.

Table with 5 columns: Block Name, Block Use, Block SubUse, Block Structure, Block Land Use Category. Row includes A (A) Residential Semidetached Bldg upto 11.5 mt. HL R.

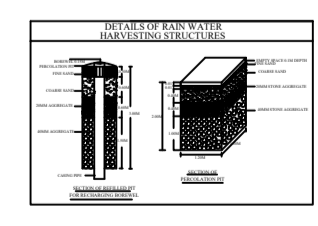

OWNER / GPA HOLDER'S SIGNATURE

ARCHITECT/ENGINEER /SUPERVISOR'S SIGNATURE KIRAN KUMAR DS No.338, Talakaveri Inayat Amruthahalli, Bangalore-92, Mob:953865

PROJECT TITLE : PLAN SHOWING THE PROPOSED RESIDENTIAL BUILDING AT SITE NO:13/2,KATHA NO:1006/55/10/1132,AMRUTHAHALLI VILLAGE,WARD NO:07,BANGALORE.

DRAWING TITLE : 1993294236-16-07-202109-40-115\_\$2117 K ABDUL :: A (A) with GF+1UF

SHEET NO : 1

Table with 2 columns: SANCTIONING AUTHORITY (Assistant Town Planner, Assistant Director) and approval text: This approval of Building plan/ Modified plan is valid for two years from the date of issue of plan and building licence by the competent authority.

YELAHANKA